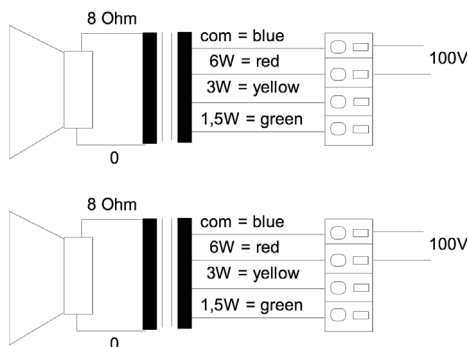
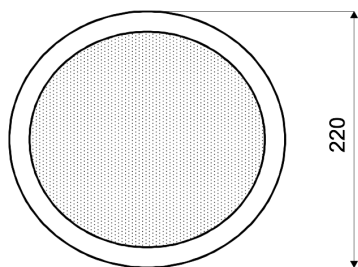
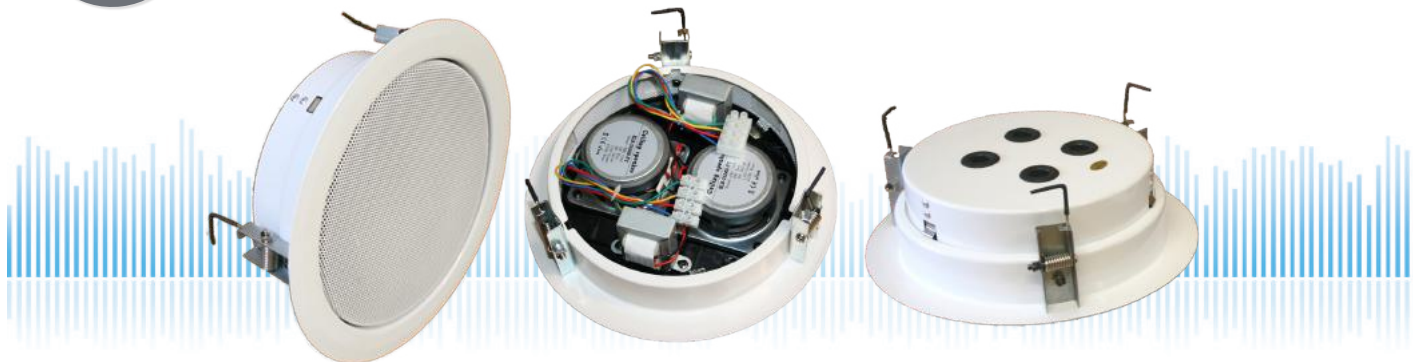

FRED-220-AB-FLAT/EN5424

EN 54-24 Ceiling-Speaker

in ALU / stainless steel with 2x 6 Watt Power for AB - Systems

TECHNICAL DATA

FRED-220-AB-FLAT/EN5424

Loudspeaker:	2x 66 mm broadband
Power-Consumption:	2x 100V-6-3-1,5W
Frequency-Range:	150-20 000 Hz
EN-Sensitivity 1W/4M:	70 dB (1x), 76 dB (2x)
SPL max 6W/4M:	78 dB (1x), 84 dB (2x)
SPL 1W/1M max. EASE/Ulysses:	102 dB (2 kHz) (double)
SPL 6W/1M max. EASE/Ulysses:	107 dB (2 kHz) (double)
Radiation H (0,5/1/2/4KHz):	180°/180°/167°/92° (single)
Radiation V (0,5/1/2/4KHz):	180°/180°/167°/92° (single)
Dimensions:	220 x 65 mm with firedome
Ceiling Cut-out:	205 mm
Suitable slab thickness:	1 mm - 35 mm
Weight:	1,5 kg with firedome
Material:	ALU / stainless steel
Color:	RAL 9010
Certificate-Nr.:	1293-CPR-0574
Order-Nr.:	FRED-220-AB-FLAT/EN5424

- Mounting depth only 65 mm with firedome
- Only 220 mm external diameter on two oval 66 mm systems
- 100 mm mounting depth with firedome
- Two autonomous loudspeaker/100V-transformer per system
- Two-part design via bayonet mounting
- Specifically designed in aluminum/stainless steel for toilet areas and other similar environments
- Custom colors by request
- Three touch-secure 100V-tappings
- Ceramic clamp & thermal fuse by request

FRED-220-AB-FLAT/EN5424

EN 54-24 Ceiling-Speaker

in ALU / stainless steel with 2x 6 Watt Power for AB - Systems

Radiation

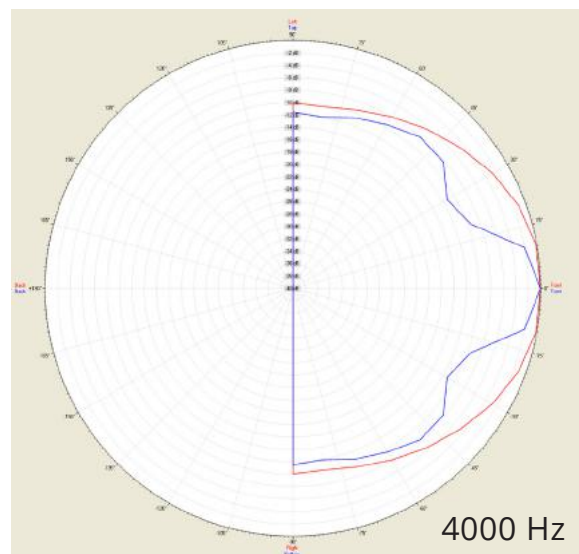
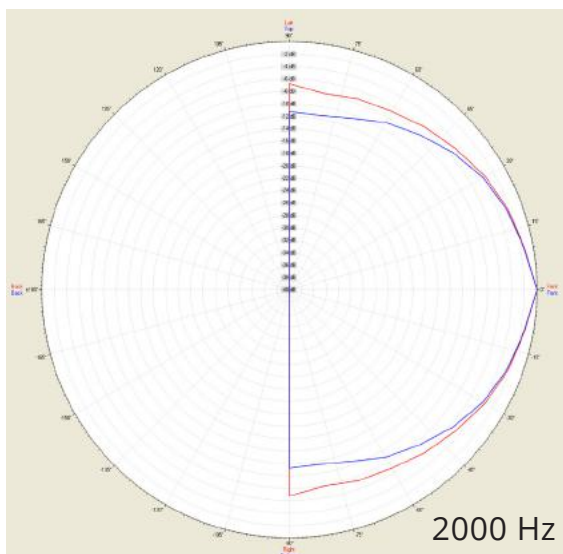
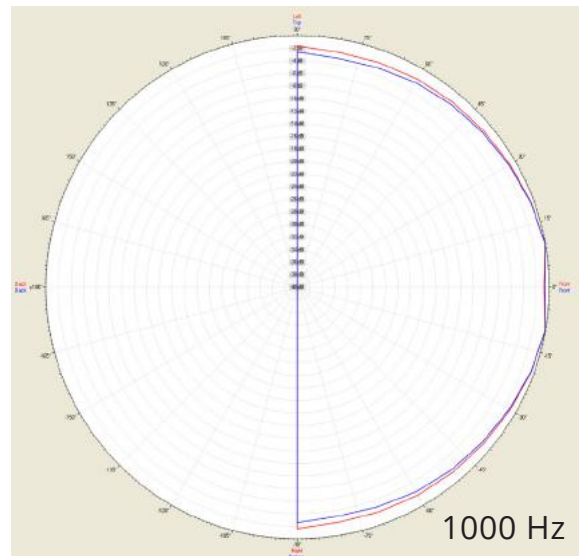
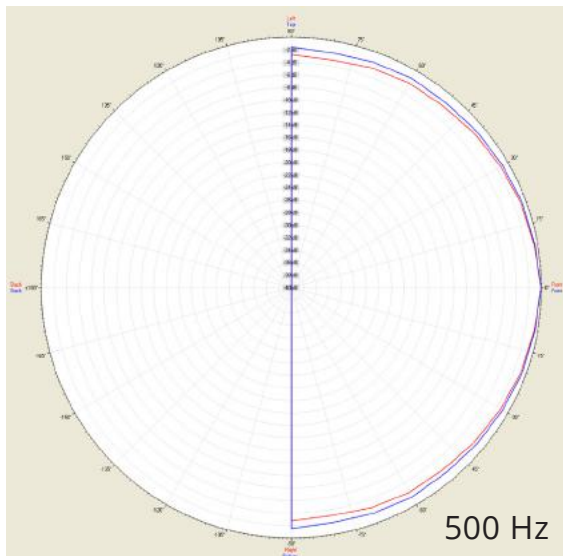

Test method	Axis	500 Hz	1000 Hz	2000 Hz	4000 Hz
EN 54-24	HOR	180°	180°	167°	92°
EN 54-24	VER	180°	180°	167°	92°
EASE/Ulysses	HOR	180°	180°	105°	85°
EASE/Ulysses	VER	180°	180°	90°	35°

FRED-220-AB-FLAT/EN5424

EN 54-24 Ceiling-Speaker

in ALU / stainless steel with 2x 6 Watt Power for AB - Systems



Elektroakustische Komponenten

Isobar-diagram

Horizontal Isobars of: Elko Schmid FRED-220-AB FLAT double

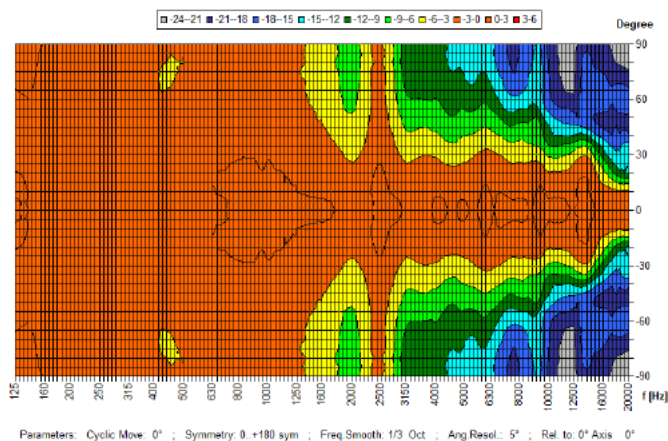

Vertical Isobars of: Elko Schmid FRED-220-AB FLAT double

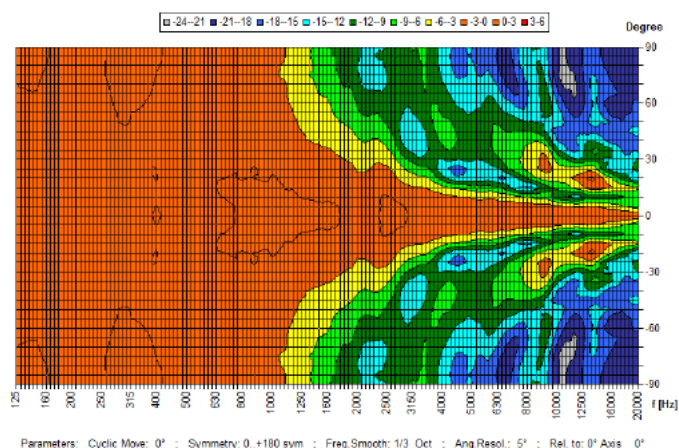

CE

1293

Elko Schmid GmbH & Co. KG
Glauchauer Str. 30, D-08058 Zwickau

18

DoP: 498058129314-ICS-PN-0010

EN 54-24

Loudspeaker for voice alarm systems for
fire detection and fire alarm systems for buildings

FRED-220-AB-FLAT/EN5424

Intended Option:
Type A